

DVP-SA2

Instruction Sheet

安 裝 說 明

安 裝 說 明

Programmable Logic Controller

可程式控制器

可編程控制器

DVP-0180030-01
20201216



Thank you for choosing Delta DVP-SA2. DVP-SA2 is embedded with a 12-point (8DI + 4DO) and a 28-point (16DI + 12DO) PLC MPU, offering various instructions and with 16k steps program memory, able to connect to all DVP-S series extension modules and high-speed extension modules, including digital I/O (max. 480 I/O points) and analog modules (for A/D, D/A conversion and temperature measurement). 2 points of 100 kHz and 2 points of 10 kHz high-speed pulse output satisfy all kinds of applications. DVP-SA2 series PLCs are battery-free, small in size and easy-to-install. The PLC programs and the latched data are stored in the high-speed flash memories.

- EN ✎ This guide provides information concerning features, electrical specifications and wiring, which should be brought to the attention of users. For other information related to programming and commands, please refer to DVP-SA2 Operation Manual, while the shipped installation instruction details the optional peripherals.
- EN ✎ DVP-SA2 is an OPEN-TYPE device. It should be installed in a control cabinet free of airborne dust, humidity, electric shock and vibration. To prevent non-maintenance staff from operating DVP-SA2, or to prevent an accident from damaging DVP-SA2, the control cabinet in which DVP-SA2 is installed should be equipped with a safeguard. For example, the control cabinet in which DVP-SA2 is installed can be unlocked with a special tool or key.
- EN ✎ DO NOT connect AC power to any of I/O terminals, otherwise serious damage may occur. Please check all wiring again before DVP-SA2 is powered up. After DVP-SA2 is disconnected, Do NOT touch any terminals in a minute. Make sure that the ground terminal ⚡ on DVP-SA2 is correctly grounded in order to prevent electromagnetic interference.
- FR ✎ Ce guide fournit des informations concernant les caractéristiques, les spécifications électriques et le câblage, qui doivent être portées à l'attention des utilisateurs. Pour d'autres informations relatives à la programmation et aux commandes, veuillez consulter le Manuel Utilisation du DVP-SA2, tandis que les instructions d'installation fournies avec le produit, détaillent les périphériques optionnels.
- FR ✎ DVP-SA2 est un module OUVERT. Il doit être installé que dans une enceinte protectrice (boîtier, armoire, etc.) saine, dépourvue de poussière, d'humidité, de vibrations et hors d'atteinte des chocs électriques. La protection doit éviter que les personnes non habilitées à la maintenance puissent accéder à l'appareil (par exemple, une clé ou un outil doivent être nécessaire pour ouvrir a protection).
- FR ✎ Ne pas appliquer la tension secteur sur les bornes d'entrées/Sorties, ou l'appareil DVP-SA2 pourra être endommagé. Merci de vérifier encore une fois le câblage avant la mise sous tension du DVP-SA2. Lors de la déconnection de l'appareil, ne pas toucher les connecteurs dans la minute suivante. Vérifier que la terre est bien reliée au connecteur de terre ⚡ afin d'éviter toute interférence électromagnétique.

■ Product Profiles

A. DVP12SA2

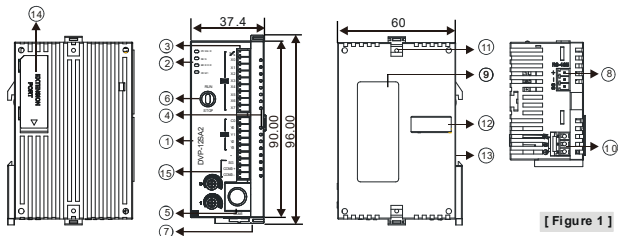

[Figure 1]

Unit: mm

B. DVP28SA2

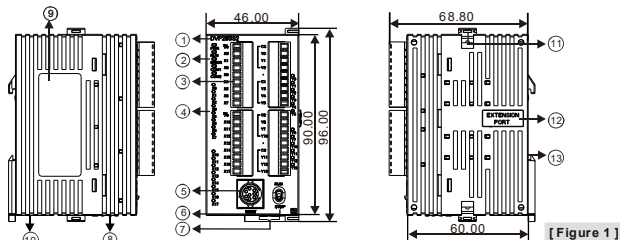

[Figure 1]

Unit: mm

1. Model name	9. Nameplate
2. POWER, RUN, ERROR, COM1, COM2 indicator	10. DC power input
3. I/O terminals	11. Extension unit clip
4. I/O point/COM3 indicator	12. Extension port
5. COM1 (RS-232) port	13. DIN rail mounting slot (35mm)
6. RUN/STOP switch	14. High speed I/O connector (Only support by DVP12SA2)
7. DIN rail clip	15. COM3 (RS-485) port (Only support by DVP12SA2)
8. COM2 (RS-485) port	

■ Electrical Specifications

Item	DVP Models				
	12SA211R	12SA211T	28SA211R	28SA211T	28SA211S
Power supply voltage	24 VDC (-15 to 20%) (with counter-connection protection on the polarity of DC input power) DVPPS01/PS02: input 100 to 240 VAC, output 24 VDC/1A (PS02: 2A)				
Connector	European standard removable terminal block (Pin pitch: 3.5mm)				
Operation	Maximum power loss time is 10ms or less.				
Inrush current	Max. 7.5 A@24 VDC, I ² t = 0.25A ² S				
Fuse capacity	2.5 A/30 VDC, Polyswitch				
Power consumption	1.8 W	1.5 W	2.9W	1.7W	1.7W
Power protection	With counter-connection protection on the polarity of DC input power				
Insulation resistance	> 5MΩ (all I/O point-to-ground: 500 VDC)				
Noise immunity	ESD (IEC 61131-2, IEC 61000-4-2): 8kV Air Discharge EFT (IEC 61131-2, IEC 61000-4-4): Power Line: 2kV, Digital I/O: 1kV, Analog & Communication I/O: 1kV RS (IEC 61131-2, IEC 61000-4-3): 26MHz ~ 1GHz, 10V/m				
Grounding	The diameter of grounding wire cannot be smaller than the wire diameter of terminals L and N (All DVP units should be grounded directly to the ground pole).				
Operation / storage	Operation: 0 to 55°C (temp.), 5 to 95% (humidity), Pollution degree 2 Storage: -25 to 70°C (temp.), 5 to 95% (humidity) Non-condensing				

DVP Models	12SA211R	12SA211T	28SA211R	28SA211T	28SA211S
Item					
Vibration / shock resistance	International standards: IEC61131-2, IEC 68-2-6 (TEST Fc)/IEC61131-2 & IEC 68-2-27 (TEST Ea)				
Weight (g)	140g	131g	171g	134g	135g

Item	Spec.	Input Points		
		12SA2 / 28SA2		28SA2
Input No.		X0 ~ X2 (12SA2) X0 ~ X3 (28SA2)	X3 ~ X7 (12SA2) X4 ~ X7 (28SA2)	X10~X17
Input type		DC (SINK or SOURCE)		
Input current (±10%)		24 VDC · 5 mA		
Input impedance		4.7 kΩ		
Max. frequency		100 kHz	10 kHz	50Hz
Action level	Off → On	> 15 VDC		
	On → Off	< 5 VDC		
Response time	Off → On	< 2.5 μs	< 20 μs	<10ms
	On → Off	< 5 μs	< 50 μs	<10ms
Filter time		Adjustable within 0 ~ 20ms by D1020 (Default: 10ms)		

Item	Spec.	Output Points				
		Relay	Transistor (NPN & PNP)			
Output No.		Y0 ~ Y3	Y0, Y2	Y1, Y3	Y10~Y13	
Max. frequency		1 Hz	100 kHz	10 kHz	1kHz ^{#5}	
Working voltage		100~250 VAC, 5~30 VDC ^{#4}	5 ~ 30 VDC ^{#1}			
Leak current		-	<100uA			
Max. load	Resistive	1.5 A / 1 point (5 A/COM)		0.5 A/1 point (4 A/COM)		
	Inductive	#2		15 W (30 VDC)		
	Lamp	20 WDC/100 WAC		2.5 W (30 VDC)		
Min. load		1mA / 5V		1mA/5V		
Response time	Off → On	Approx. 10 ms		2 μs ^{#3}	20 μs ^{#3}	100μs ^{#3}
	On → Off			3 μs ^{#3}	30 μs ^{#3}	100μs ^{#3}

#1: UP, ZP must work with external auxiliary power supply 24 VDC (-15 to +20%), rated consumption approx. 1mA/point.

#2: Relay contact life can be influenced by operating voltage , load types(cosφ/ t) and contact current rating. Figure 2 below shows the number of operations for reference.

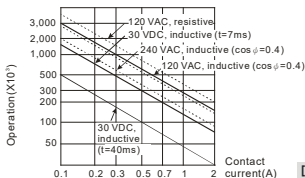

[Figure 2]

#3: Load = 0.5A

#4: The max. Output speed is influenced by the actual PLC scan time.

■ I/O Configuration

12SA211R	12SA211T	28SA211R	28SA211T	28SA211S																																																																																				
Relay 8IN/4OUT	Transistor (NPN) 8IN/4OUT	Relay 16IN/12OUT	Transistor (NPN) 16IN/12OUT	Transistor (PNP) 16IN/12OUT																																																																																				
DC (Sink or Source)																																																																																								
<table border="1"> <tr><td>S/S</td></tr><tr><td>X0</td></tr><tr><td>X1</td></tr><tr><td>X2</td></tr><tr><td>X3</td></tr><tr><td>X4</td></tr><tr><td>X5</td></tr><tr><td>X6</td></tr><tr><td>X7</td></tr><tr><td>C0</td></tr><tr><td>Y0</td></tr><tr><td>Y1</td></tr><tr><td>Y2</td></tr><tr><td>Y3</td></tr><tr><td>●</td></tr><tr><td>S/G</td></tr><tr><td>COM3+</td></tr><tr><td>COM3-</td></tr></table>	S/S	X0	X1	X2	X3	X4	X5	X6	X7	C0	Y0	Y1	Y2	Y3	●	S/G	COM3+	COM3-	<table border="1"> <tr><td>S/S</td></tr><tr><td>X0</td></tr><tr><td>X1</td></tr><tr><td>X2</td></tr><tr><td>X3</td></tr><tr><td>X4</td></tr><tr><td>X5</td></tr><tr><td>X6</td></tr><tr><td>X7</td></tr><tr><td>Y0</td></tr><tr><td>Y1</td></tr><tr><td>Y2</td></tr><tr><td>Y3</td></tr><tr><td>UP</td></tr><tr><td>ZP</td></tr><tr><td>S/G</td></tr><tr><td>COM3+</td></tr><tr><td>COM3-</td></tr></table>	S/S	X0	X1	X2	X3	X4	X5	X6	X7	Y0	Y1	Y2	Y3	UP	ZP	S/G	COM3+	COM3-	<table border="1"> <tr><td>S/S</td></tr><tr><td>X0</td></tr><tr><td>X1</td></tr><tr><td>X2</td></tr><tr><td>X3</td></tr><tr><td>X4</td></tr><tr><td>X5</td></tr><tr><td>X6</td></tr><tr><td>X7</td></tr><tr><td>C1</td></tr><tr><td>Y3</td></tr><tr><td>Y4</td></tr><tr><td>Y5</td></tr><tr><td>C2</td></tr><tr><td>Y6</td></tr><tr><td>Y7</td></tr><tr><td>Y10</td></tr><tr><td>●</td></tr><tr><td>C3</td></tr><tr><td>Y11</td></tr><tr><td>Y12</td></tr><tr><td>Y13</td></tr></table>	S/S	X0	X1	X2	X3	X4	X5	X6	X7	C1	Y3	Y4	Y5	C2	Y6	Y7	Y10	●	C3	Y11	Y12	Y13	<table border="1"> <tr><td>S/S</td></tr><tr><td>X0</td></tr><tr><td>X1</td></tr><tr><td>X2</td></tr><tr><td>X3</td></tr><tr><td>X4</td></tr><tr><td>X5</td></tr><tr><td>X6</td></tr><tr><td>X7</td></tr><tr><td>UP0</td></tr><tr><td>ZP0</td></tr><tr><td>Y0</td></tr><tr><td>Y1</td></tr><tr><td>Y2</td></tr><tr><td>Y3</td></tr><tr><td>Y4</td></tr><tr><td>Y5</td></tr><tr><td>Y6</td></tr><tr><td>Y7</td></tr><tr><td>●</td></tr><tr><td>UP1</td></tr><tr><td>ZP1</td></tr><tr><td>Y10</td></tr><tr><td>Y11</td></tr><tr><td>Y12</td></tr><tr><td>Y13</td></tr><tr><td>●</td></tr></table>	S/S	X0	X1	X2	X3	X4	X5	X6	X7	UP0	ZP0	Y0	Y1	Y2	Y3	Y4	Y5	Y6	Y7	●	UP1	ZP1	Y10	Y11	Y12	Y13	●
S/S																																																																																								
X0																																																																																								
X1																																																																																								
X2																																																																																								
X3																																																																																								
X4																																																																																								
X5																																																																																								
X6																																																																																								
X7																																																																																								
C0																																																																																								
Y0																																																																																								
Y1																																																																																								
Y2																																																																																								
Y3																																																																																								
●																																																																																								
S/G																																																																																								
COM3+																																																																																								
COM3-																																																																																								
S/S																																																																																								
X0																																																																																								
X1																																																																																								
X2																																																																																								
X3																																																																																								
X4																																																																																								
X5																																																																																								
X6																																																																																								
X7																																																																																								
Y0																																																																																								
Y1																																																																																								
Y2																																																																																								
Y3																																																																																								
UP																																																																																								
ZP																																																																																								
S/G																																																																																								
COM3+																																																																																								
COM3-																																																																																								
S/S																																																																																								
X0																																																																																								
X1																																																																																								
X2																																																																																								
X3																																																																																								
X4																																																																																								
X5																																																																																								
X6																																																																																								
X7																																																																																								
C1																																																																																								
Y3																																																																																								
Y4																																																																																								
Y5																																																																																								
C2																																																																																								
Y6																																																																																								
Y7																																																																																								
Y10																																																																																								
●																																																																																								
C3																																																																																								
Y11																																																																																								
Y12																																																																																								
Y13																																																																																								
S/S																																																																																								
X0																																																																																								
X1																																																																																								
X2																																																																																								
X3																																																																																								
X4																																																																																								
X5																																																																																								
X6																																																																																								
X7																																																																																								
UP0																																																																																								
ZP0																																																																																								
Y0																																																																																								
Y1																																																																																								
Y2																																																																																								
Y3																																																																																								
Y4																																																																																								
Y5																																																																																								
Y6																																																																																								
Y7																																																																																								
●																																																																																								
UP1																																																																																								
ZP1																																																																																								
Y10																																																																																								
Y11																																																																																								
Y12																																																																																								
Y13																																																																																								
●																																																																																								

Note: The layout of output terminals on DVP-SA2 is different from that on DVP-SA.

■ Dimension & Installation

Please install the PLC in an enclosure with sufficient space around it to allow heat dissipation, See [Figure 3].

- **Direct Mounting:** Use M4 screw according to the dimension of the product.
- **DIN Rail Mounting:** When mounting the PLC to 35mm DIN rail, be sure to use the retaining clip to stop any side-to-side movement of the PLC and reduce the chance of wires being loose. The retaining clip is at the bottom of the PLC. To secure the PLC to DIN rail, pull down the clip, place it onto the rail and gently push it up. To remove the PLC, pull the retaining clip down with a flat screwdriver and gently remove the PLC from DIN rail.

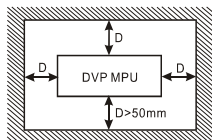

[Figure 3]

■ Wiring

1. Use 22-16AWG (1.5mm) single or multiple core wire on I/O wiring terminals. See the figure in the right hand side for its specification. PLC terminal screws should be tightened to 1.90 kg-cm (1.65 in-lbs) and please use only 60/75°C copper conductor.
2. DO NOT wire empty terminal. DO NOT place the I/O signal cable in the same wiring circuit.
3. DO NOT drop tiny metallic conductor into the PLC while screwing and wiring. Tear off the sticker on the heat dissipation hole for preventing alien substances from dropping in to ensure normal heat dissipation of the PLC.

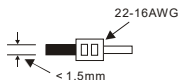

◆ Power Supply

The power input of DVP-SA2 is DC. When operating DVP-SA2, please note the following points:

1. The power is connected to two terminals, 24 VDC and 0 V, and the range of power is 20.4 to 28.8 VDC. If the power voltage is less than 17.5 VDC, the PLC will stop running, all outputs will go "Off", and the ERROR indicator will start to blink continuously.
2. The power shutdown for less than 10ms will not affect the operation of the PLC. However, the shutdown time that is too long or the drop of power voltage will stop the operation of the PLC, and all outputs will go off. When the power returns to normal status, the PLC will automatically resume the operation. (Please take care of the latched auxiliary relays and registers inside the PLC when doing the programming).

◆ Safety Wiring

Since DVP-SA2 is only compatible with DC power supply, Delta's power supply modules (DVPPS01/DVPPS02) are the suitable power supplies for DVP-SA2. We suggest you install the protection circuit at the power supply terminal to protect DVPPS01 or DVPPS02. See the figure below.

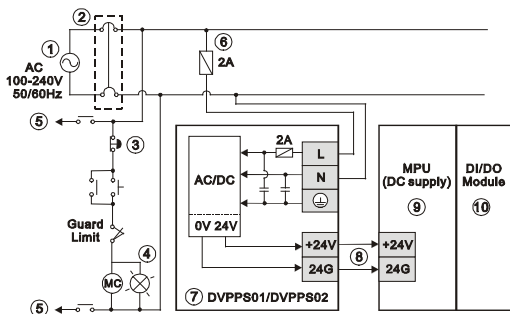

[Figure 4]

① AC power supply: 100 ~ 240VAC, 50/60Hz ② Breaker

③ Emergency stop: This button cuts off the system power supply when accidental emergency takes place.

④ Power indicator

⑤ AC power supply load

⑥ Power supply circuit protection fuse (2A)

⑦ DVPPS01/DVPPS02

⑧ DC power supply output: 24 VDC, 500 mA

⑨ DVP-PLC (main processing unit)

⑩ Digital I/O module

◆ Input Point Wiring

There are 2 types of DC inputs, SINK and SOURCE. (See the example below. For detailed point configuration, please refer to the specification of each model.)

● DC Signal IN – SINK mode

Input point loop equivalent circuit

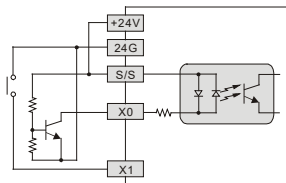

[Figure 5]

● DC Signal IN – SOURCE mode

Input point loop equivalent circuit

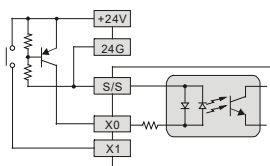

[Figure 6]

◆ Output Point Wiring

1. DVP-SA2 has two output modules on it, relay and transistor. Be aware of the connection of shared terminal when wiring output terminals.
2. Relay output terminals Y0 to Y3 of 12SA2 relay model use C0 common port. See [Figure 7]. For 28SA211R relay model, see [Figure 8]. When the output points are enabled, their corresponding indicators on the front panel will be on.
3. Transistor output terminals, Y0 to Y3 of transistor (NPN) models use UP, ZP common port. For 12SA2-T, 28SA2-T and 28SA2-S models, See [Figure 9], [Figure 10] and [Figure 11].

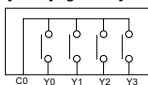

[Figure7]

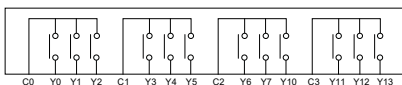

[Figure8]

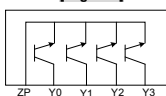

[Figure9]

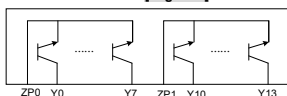

[Figure10]

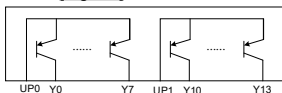

[Figure11]

4. Isolation circuit: The optical coupler is used to isolate signals between the circuit inside PLC and the output side of the circuit.

● Relay (R) output circuit wiring

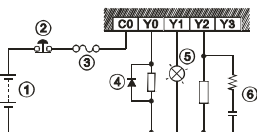

[Figure12]

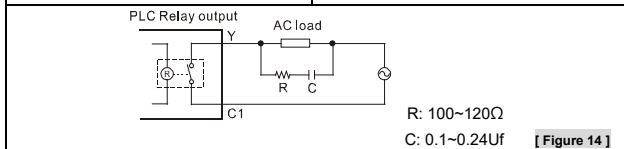
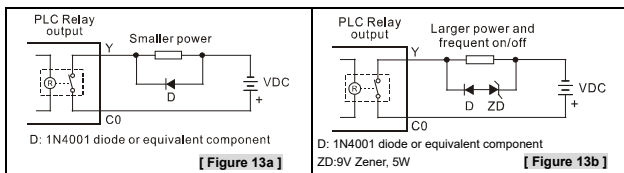

- | | |
|--|--|
| ① DC power supply | ② Emergency stop: Uses external switch |
| ③ Fuse: 5 to 10A fuse at the shared terminal of output contacts to protect the output circuit | |
| ④ Transient voltage suppressor (SB360 3A 60V): Extends the life span of contact. <ol style="list-style-type: none"> 1. Diode suppression of DC load: Used when in smaller power [Figure 10a] 2. Diode + Zener suppression of DC load: Used when in larger power and frequent On/Off [Figure 10b] | |
| ⑤ Incandescent light (resistive load) | |
| ⑥ Absorber: Reduces the interference on AC load [Figure 11] | |

• Transistor (T) output circuit wiring

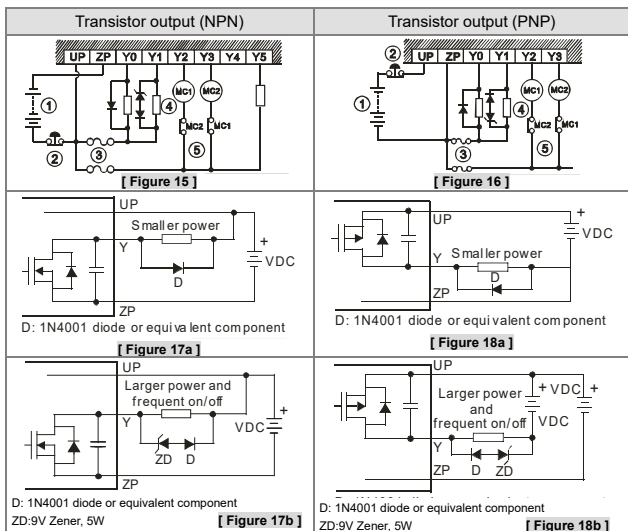

① DC power supply ② Emergency stop ③ Circuit protection fuse

- ④ The output of the transistor model is "open collector". If Y0/Y1 is set to pulse output, the output current has to be bigger than 0.1 A to ensure normal operation of the model.
1. Diode suppression: Used when in smaller power [Figure 17a] [Figure 18a]
 2. Diode + Zener suppression: Used when in larger power and frequent On/Off [Figure 17b] [Figure 18b]
- ⑤ Manually exclusive output: For example, Y2 and Y3 control the forward running and reverse running of the motor, forming an interlock for the external circuit, together with the PLC internal program, to ensure safe protection in case of any unexpected errors.

◆ RS-485 Wiring

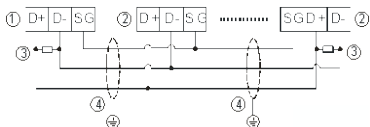

[Figure 19]

DVP12SA2 provides one set for each COM2 and COM3 [Figure 19], while DVP28SA2 only provides one set of COM2.

① Master node ② Slave node
③ Terminal resistor ④ Shielded cable

Note:

1. Terminal resistors are suggested to be connected to master and the last slave with resistor value of 120Ω.
2. To ensure communication quality, please apply double shielded twisted pair cable (20AWG) for wiring.

■ Precision of the RTC (Second/Month)

Temperature (°C/°F)	0/32	25/77	55/131
Maximum error (Second)	-117	52	-132

Duration in which the RTC is latched: One week

感謝您採用台達 DVP 系列可程式控制器。DVP-SA2 分別有內建 12 點 (8 數位輸入點 + 4 數位輸出點) 與 28 點 (16 數位輸入點 + 12 數位輸出點) PLC 主機，提供豐富的指令集，並具有 16k steps 的程式記憶體，可連接薄型全系列 I/O 模組與 12 點主機可連接左側高速擴充模組，包含數位輸入 / 輸出 (最大輸入 / 輸出擴充點數可達 480 點)、及類比模組 (A/D、D/A 轉換及溫度單元)。兩點 100 kHz 與兩點 10 kHz 高速脈波輸出可滿足各種應用場合，並且體積小，安裝容易。全系列採用免電池設計，其 PLC 程式與停電保持資料皆運用高速快閃記憶體儲存。

- ✦ 本安裝說明書提供給使用者電氣規格、功能規格、安裝配線之相關注意事項。其他詳細之程式設計及指令說明請見《DVP-SA2 操作手冊：程式篇》，選購之周邊裝置詳細說明請見該產品隨機安裝說明書。
- ✦ 本機為開放型 (OPEN TYPE) 機殼，因此使用者使用本機時，必須將之安裝於具防塵、防潮及免於電擊 / 衝擊意外之外殼配線箱內。另必須具備保護措施 (如：特殊之工具或鑰匙才可打開) 防止非維護人員操作或意外衝擊本體，造成危險及損壞。
- ✦ 交流輸入電源不可連接於輸入 / 出信號端，否則可能造成嚴重損壞，請在上電之前再次確認電源配線。請勿在上電時觸摸任何端子。本體上之接地端子 ⚡ 務必正確的接地，可提高產品抗雜訊能力。

■ 產品外觀部位介紹

- 詳細外觀圖示請參閱英文版 [Figure 1]。單位：mm。

1. 機種名稱	9. 標籤
2. 電源、運行、錯誤、COM1、COM2 狀態指示燈	10. 電源輸入口
3. 輸入/輸出端子	11. I/O 模組固定扣
4. 輸入/輸出/COM3 指示燈	12. I/O 模組連接口
5. COM1 (RS-232) 通訊埠	13. DIN 軌槽 (35mm)
6. RUN/STOP 開關	14. 左側高速 I/O 模組連接口 (僅 DVP12SA2 支援)
7. DIN 軌固定扣	15. COM3 (RS-485) 通訊埠 (僅 DVP12SA2 支援)
8. COM2 (RS-485) 通訊埠	

■ 電氣規格

項目	機種 DVP				
	12SA211R	12SA211T	28SA211R	28SA211T	28SA211S
電源電壓	24 VDC (-15 ~ 20%) (具直流輸入電源極性反接保護) DVPPS01/PS02：輸入 100 ~ 240 VAC，輸出 24 VDC/1A (PS02: 2A)				
連接方式	脫落式歐式端子座 (端點距離：3.5mm)				
動作規格	最大電源斷電時間 ≤ 10ms				
突入電流	Max. 7.5 A@24 VDC, I ² t = 0.25A ² S				
電源保險絲容量	2.5 A/30 VDC，可恢復式 (Polyswitch)				
消耗功率	1.8 W	1.5 W	2.9W	1.7W	1.7W
電源保護	具直流輸入電源極性反接保護				
絕緣阻抗	> 5MΩ (所有輸出 / 入點對地之間 500 VDC)				
雜訊免疫力	ESD (IEC 61131-2, IEC 61000-4-2): 8kV Air Discharge EFT (IEC 61131-2, IEC 61000-4-4): Power Line: 2kV, Digital I/O: 1kV, Analog & Communication I/O: 1kV RS (IEC 61131-2, IEC 61000-4-3): 26MHz ~ 1GHz, 10V/m				

機種 DVP	12SA211R	12SA211T	28SA211R	28SA211T	28SA211S
項目					
接地	接地配線之線徑不得小於電源端配線線徑（多台 PLC 同時使用時，請務必單點接地）				
操作 / 儲存環境	操作：0 ~ 55°C（溫度），5 ~ 95%（濕度），污染等級 2 儲存：-25 ~ 70°C（溫度），5 ~ 95%（濕度） 不可凝結				
耐振動 / 衝擊	國際標準規範 IEC61131-2, IEC 68-2-6 (TEST Fc)/IEC61131-2 & IEC 68-2-27 (TEST Ea)				
重量(g)	140g	131g	171g	134g	135g

項目	機種	輸入點電氣規格(單端共點輸入)		
		12SA2 / 28SA2		28SA2
輸入點 No.		X0 ~ X2 (12SA2) X0 ~ X3 (28SA2)	X3 ~ X7 (12SA2) X4 ~ X7 (28SA2)	X10~X17
輸入接線型式		由端子 S/S 變換接線為 SINK 或 SOURCE		
輸入信號電壓 (±10%)		24 VDC , 5 mA		
輸入點阻抗		4.7 kΩ		
最大輸入頻率		100 kHz	10 kHz	50Hz
動作位準	Off → On	> 15 VDC		
	On → Off	< 5 VDC		
反應時間	Off → On	< 2.5 μs	< 20 μs	<10ms
	On → Off	< 5 μs	< 50 μs	<10ms
雜訊抑制		< 5 μs	< 50 μs	<10ms
濾波時間		由 D1020 可作 0 ~ 20 ms 的調整（預設：10 ms）		

項目	機種	輸出點電氣規格			
		繼電器		電晶體(NPN & PNP)	
輸出點 No.		Y0 ~ Y3		Y0, Y2	Y1, Y3 Y10~Y13
最高交換頻率		1 Hz		100 kHz	10 kHz 1kHz ^{#5}
電壓規格		100~250 VAC, 5~30 VDC ^{#4}		5 ~ 30 VDC ^{#1}	
漏電流		-		<100uA	
最大負載	電阻性	1.5 A / 1 點 (5 A/COM)		0.5 A/1 點 (4 A/COM)	
	電感性	#2		15 W (30 VDC)	
	燈泡	20 WDC/100 WAC		2.5 W (30 VDC)	
最小負載		1mA / 5V		1mA/5V	
反應時間	Off → On	約 10 ms		2 μs ^{#3}	20 μs ^{#3} 100μs ^{#3}
	On → Off			3 μs ^{#3}	30 μs ^{#3} 100μs ^{#3}

#1：UP, ZP 必須外加輔助電源 24 VDC (-15 ~ +20%) 額定消耗約 1 mA / 點。

#2：繼電器接點壽命隨著工作電壓、負載種類(功率因素 $\cos\theta$ 、時間常數 t)、及接點電流大小而有所不同，參考生命週期曲線圖預估可操作次數。生命週期曲線圖請參閱英文版 [Figure 2]。

#3：負載條件為 0.5A。

#4：此處最高輸出速度會受實際 PLC 掃描時間影響。

■ 輸入/輸出配置

12SA211R	12SA211T	28SA211R	28SA211T	28SA211S																																																																																									
繼電器 8IN/4OUT	電晶體(NPN) 8IN/4OUT	繼電器 16IN/12OUT	電晶體(NPN) 16IN/12OUT	電晶體(PNP) 16IN/12OUT																																																																																									
直流 (Sink or Source)																																																																																													
<table border="1"> <tr><td>S/S</td></tr><tr><td>X0</td></tr><tr><td>X1</td></tr><tr><td>X2</td></tr><tr><td>X3</td></tr><tr><td>X4</td></tr><tr><td>X5</td></tr><tr><td>X6</td></tr><tr><td>X7</td></tr><tr><td>C0</td></tr><tr><td>Y0</td></tr><tr><td>Y1</td></tr><tr><td>Y2</td></tr><tr><td>Y3</td></tr><tr><td>●</td></tr><tr><td>S/G</td></tr><tr><td>COM3+</td></tr><tr><td>COM3-</td></tr> </table>	S/S	X0	X1	X2	X3	X4	X5	X6	X7	C0	Y0	Y1	Y2	Y3	●	S/G	COM3+	COM3-	<table border="1"> <tr><td>S/S</td></tr><tr><td>X0</td></tr><tr><td>X1</td></tr><tr><td>X2</td></tr><tr><td>X3</td></tr><tr><td>X4</td></tr><tr><td>X5</td></tr><tr><td>X6</td></tr><tr><td>X7</td></tr><tr><td>Y0</td></tr><tr><td>Y1</td></tr><tr><td>Y2</td></tr><tr><td>Y3</td></tr><tr><td>UP</td></tr><tr><td>ZP</td></tr><tr><td>S/G</td></tr><tr><td>COM3+</td></tr><tr><td>COM3-</td></tr> </table>	S/S	X0	X1	X2	X3	X4	X5	X6	X7	Y0	Y1	Y2	Y3	UP	ZP	S/G	COM3+	COM3-	<table border="1"> <tr><td>S/S</td></tr><tr><td>X0</td></tr><tr><td>X1</td></tr><tr><td>X2</td></tr><tr><td>X3</td></tr><tr><td>X4</td></tr><tr><td>X5</td></tr><tr><td>X6</td></tr><tr><td>X7</td></tr><tr><td>C0</td></tr><tr><td>Y0</td></tr><tr><td>Y1</td></tr><tr><td>Y2</td></tr><tr><td>●</td></tr><tr><td>C1</td></tr><tr><td>Y3</td></tr><tr><td>Y4</td></tr><tr><td>Y5</td></tr><tr><td>C2</td></tr><tr><td>Y6</td></tr><tr><td>Y7</td></tr><tr><td>Y10</td></tr><tr><td>●</td></tr><tr><td>C3</td></tr><tr><td>Y11</td></tr><tr><td>Y12</td></tr><tr><td>Y13</td></tr> </table>	S/S	X0	X1	X2	X3	X4	X5	X6	X7	C0	Y0	Y1	Y2	●	C1	Y3	Y4	Y5	C2	Y6	Y7	Y10	●	C3	Y11	Y12	Y13	<table border="1"> <tr><td>S/S</td></tr><tr><td>X0</td></tr><tr><td>X1</td></tr><tr><td>X2</td></tr><tr><td>X3</td></tr><tr><td>X4</td></tr><tr><td>X5</td></tr><tr><td>X6</td></tr><tr><td>X7</td></tr><tr><td>UP0</td></tr><tr><td>ZP0</td></tr><tr><td>Y0</td></tr><tr><td>Y1</td></tr><tr><td>Y2</td></tr><tr><td>Y3</td></tr><tr><td>Y4</td></tr><tr><td>Y5</td></tr><tr><td>Y6</td></tr><tr><td>Y7</td></tr><tr><td>●</td></tr><tr><td>UP1</td></tr><tr><td>ZP1</td></tr><tr><td>Y10</td></tr><tr><td>Y11</td></tr><tr><td>Y12</td></tr><tr><td>Y13</td></tr><tr><td>●</td></tr> </table>	S/S	X0	X1	X2	X3	X4	X5	X6	X7	UP0	ZP0	Y0	Y1	Y2	Y3	Y4	Y5	Y6	Y7	●	UP1	ZP1	Y10	Y11	Y12	Y13	●
S/S																																																																																													
X0																																																																																													
X1																																																																																													
X2																																																																																													
X3																																																																																													
X4																																																																																													
X5																																																																																													
X6																																																																																													
X7																																																																																													
C0																																																																																													
Y0																																																																																													
Y1																																																																																													
Y2																																																																																													
Y3																																																																																													
●																																																																																													
S/G																																																																																													
COM3+																																																																																													
COM3-																																																																																													
S/S																																																																																													
X0																																																																																													
X1																																																																																													
X2																																																																																													
X3																																																																																													
X4																																																																																													
X5																																																																																													
X6																																																																																													
X7																																																																																													
Y0																																																																																													
Y1																																																																																													
Y2																																																																																													
Y3																																																																																													
UP																																																																																													
ZP																																																																																													
S/G																																																																																													
COM3+																																																																																													
COM3-																																																																																													
S/S																																																																																													
X0																																																																																													
X1																																																																																													
X2																																																																																													
X3																																																																																													
X4																																																																																													
X5																																																																																													
X6																																																																																													
X7																																																																																													
C0																																																																																													
Y0																																																																																													
Y1																																																																																													
Y2																																																																																													
●																																																																																													
C1																																																																																													
Y3																																																																																													
Y4																																																																																													
Y5																																																																																													
C2																																																																																													
Y6																																																																																													
Y7																																																																																													
Y10																																																																																													
●																																																																																													
C3																																																																																													
Y11																																																																																													
Y12																																																																																													
Y13																																																																																													
S/S																																																																																													
X0																																																																																													
X1																																																																																													
X2																																																																																													
X3																																																																																													
X4																																																																																													
X5																																																																																													
X6																																																																																													
X7																																																																																													
UP0																																																																																													
ZP0																																																																																													
Y0																																																																																													
Y1																																																																																													
Y2																																																																																													
Y3																																																																																													
Y4																																																																																													
Y5																																																																																													
Y6																																																																																													
Y7																																																																																													
●																																																																																													
UP1																																																																																													
ZP1																																																																																													
Y10																																																																																													
Y11																																																																																													
Y12																																																																																													
Y13																																																																																													
●																																																																																													

註：本機種輸出端子配置與 DVP-SA 系列不同，使用時請注意配線之變更。

■ 安裝方式

PLC 在安裝時，請裝配於封閉式之控制箱內，其周圍應保持一定之空間，以確保 PLC 散熱功能正常，請參閱英文版 [Figure 3]。

- 直接鎖螺絲方式：請依產品外型尺寸並使用 M4 螺絲。
- DIN 鋁軌之安裝方法：適用於 35mm 之 DIN 鋁軌。在將主機掛上鋁軌時，請先將主機（或 I/O 模組）下方之固定塑膠片，以一字形起子插入凹槽並向外撐開拉出，再將主機（或 I/O 模組）掛上鋁軌，之後將固定塑膠片壓扣回去即可。欲取下主機時，同樣以一字形起子先將固定塑膠片撐開，再將主機以往外向上的方式取出即可。該固定機構塑膠片為保持型，因此撐開後便不會彈回去。

■ 配線端子

1. 輸出 / 入配線端請使用 22-16AWG (1.5mm) 單蕊裸線或多蕊線，端子規格如英文版配線端子之圖示。PLC 端子螺絲扭力為 1.90 kg-cm (1.65 in-lbs)。只能使用 60/75°C 的銅導線。
2. 空端子請勿配線。輸入點信號線與輸出點等動力線請勿置於同一線槽內。
3. 鎖螺絲及配線時請避免微小的金屬導體掉入 PLC 內部，並在配線完成後保持散熱空間。

◆ 電源端

DVP-SA2 機種為直流電源輸入，在使用上應注意下列事項：

1. 電源請接於 24 VDC 及 0 V 兩端，電源範圍為 20.4 ~ 28.8 VDC，當電源電壓低於 17.5 VDC 時，PLC 會停止運轉，輸出全部 Off，ERROR LED 快速閃爍。
2. 當停電時間低於 10 ms 時，PLC 不受影響繼續運轉，當停電時間過長或電源電壓下降將使 PLC 停止運轉，輸出全部 Off，當電源恢復正常時，PLC 亦自動回復運轉。（PLC 內部具停電保持的輔助繼電器及暫存器，使用者在規劃程式設計時應特別注意使用。）

◆ 安全配線回路

由於 DVP-SA2 的電源為 DC Only 的機種，因此可搭配台達之電源供應模組 (DVPPS01/DVPPS02) 提供電源給 DVP-SA2。為保護 DVPPS01/DVPPS02，建議可在電源的輸入回路端配置如下的保護回路，配置圖請參閱英文版[Figure 4] 所示：

① 交流電源供應：100 ~ 240 VAC, 50/60 Hz	② 斷路器
③ 緊急停止：為預防突發狀況發生，設置緊急停止按鈕，可在狀況發生時，切斷系統電源。	
④ 電源指示燈	⑤ 交流電源負載
⑥ 電源回路保護用保險絲 (2A)	⑦ DVPPS01/DVPPS02 本體
⑧ 直流電源供應輸出：24 VDC，500 mA	⑨ DVP PLC 本體
⑩ 數位輸入 / 輸出模組	

◆ 輸入點之配線

輸入點之入力信號為直流電源 DC 輸入型式，共有兩種接法：SINK 及 SOURCE，其定義與輸入點回路等效電路配線圖，請參閱英文版 [Figure 5] 及 [Figure 6]。

◆ 輸出點之配線

1. DVP-SA2 系列 PLC 輸出模組共有二種：繼電器與電晶體。輸出端在實際配線時，應特別注意共用端的連接。
2. 繼電器機種 12SA2 輸出端 Y0 ~ Y3 採用 C0 共點，請參閱英文版 [Figure 7]；28SA211R 輸出端配置之共點配置，請參閱英文版 [Figure 8]。動作指示：當輸出點動作時，正面的該點指示燈亮。
3. 電晶體機種輸出端採用 UP、ZP 共點設計，12SA2-T、28SA2-T 與 28SA2-S 之配置，請分別參閱英文版 [Figure 9]、[Figure 10] 與 [Figure 11]。
4. 隔離回路：PLC 內部回路與輸出點之間使用光耦合器作信號隔離。

● 繼電器輸出回路配線

詳細配線圖請參閱英文版 [Figure 12] ~ [Figure 14]。

① 直流電源供給	② 緊急停止：使用外部開關
③ 保險絲：使用 5 ~ 10 A 的保險絲容量於輸出接點的共用點，保護輸出點回路	
④ 突波吸收二極體：可增加接點壽命。 <ol style="list-style-type: none">1. DC 負載電源之二極體抑制：功率較小時使用（請參閱英文版 [Figure 13a]）2. DC 負載電源之二極體 + Zener 抑制：大功率且 On/Off 頻繁時使用（請參閱英文版 [Figure 13b]）	
⑤ 白熾燈（電阻性負載）	
⑥ 突波吸收器：可減少交流負載上的雜訊（請參閱英文版 [Figure 14]）	

● 電晶體輸出回路配線

詳細配線圖請參閱英文版 [Figure 15] ~ [Figure 18b]。

① 直流電源供應	② 緊急停止	③ 電路回路保護用保險絲
④ 突波吸收二極體：可增加接點壽命。 <ol style="list-style-type: none">1. DC 負載電源之二極體抑制：功率較小時使用（請參閱英文版 [Figure 17a] [Figure 18a]）2. DC 負載電源之二極體 + Zener 抑制：大功率且 On/Off 頻繁時使用（請參閱英文版 [Figure 17b] [Figure 18b]）		
⑤ 互斥輸出：例如，將 Y2 與 Y3 用以控制對應馬達的正轉及反轉，使外部電路形成互鎖，配合 PLC 內部程式，確保任何異常突發狀況發生時，均有安全的保護措施。		

◆ RS-485 建議接線

詳細接線圖請參閱英文版 [Figure 19]。DVP12SA2 提供 COM2, COM3 兩組；DVP28SA2 僅提供 COM2 一組。

① 主站

② 從站

③ 終端電阻

④ 遮蔽線

註：1. 終端電阻建議連接於主站及最後一台從站上，且其電阻值建議為 120Ω 。

2. 為確保連線品質，線材建議使用具有雙層遮蔽線之通訊雙絞線 (20AWG)。

■ 萬年曆的精度 (秒 / 月)

溫度 (°C/°F)	0/32	25/77	55/131
最大誤差 (秒)	-117	52	-132

萬年曆停電保持時間：一週

感谢您采用台达 DVP 系列可编程控制器。DVP-SA2 分别有内建 12 点(8 数字量输入点 + 4 数字量输出点)与 28 点(16 数字输入点 + 12 数字输出点) PLC 主机, 提供丰富的指令集, 并具有 16k steps 的程序内存, 可连接薄型全系列 I/O 模块与 12 点主机可连接左侧高速扩展模块, 包含数字量输入/输出(最大输入/输出扩展点数可达 480 点)、及模拟量模块(A/D、D/A 转换及温度单元)。两点 100 kHz 与两点 10 kHz 高速脉冲输出可满足各种应用场合, 并且体积小, 安装容易。全系列采用免电池设计, 其 PLC 程序与停电保持数据皆运用高速闪存储存。

- ✦ 本安装说明书提供给使用者电气规格、功能规格、安装配线的相关注意事项。其它详细的程序设计及指令说明请见《DVP-SA2 操作手册：程序篇》，选购的周边装置详细说明请见该产品随机安装说明书。
- ✦ 本机为开放型 (OPEN TYPE) 机种, 因此使用者使用本机时, 必须将的安装于具防尘、防潮及免于电击 / 冲击意外的外壳配线箱内。另必须具备保护措施(如: 特殊的工具或钥匙才可打开)防止非维护人员操作或意外冲击本体, 造成危险及损坏。
- ✦ 交流输入电源不可连接于输入 / 出信号端, 否则可能造成严重损坏, 请在上电的前再次确认电源配线。请勿在上电时触摸任何端子。本体上的接地端子 ⊕ 务必正确的接地, 可提高产品抗干扰能力。

■ 产品外观部位介绍

- 详细外观图示请参阅英文版 [Figure 1]。单位: mm。

1. 机种名称	9. 标签
2. 电源、运行、错误、COM1、COM2 状态指示灯	10. 电源输入口
3. 输入/输出端子	11. I/O 模块固定扣
4. 输入/输出/COM3 指示灯	12. I/O 模块接口
5. COM1 (RS-232) 通讯端口	13. DIN 轨槽 (35mm)
6. RUN/STOP 开关	14. 左侧高速 I/O 模块接口 (仅 DVP12SA2 支持)
7. DIN 轨固定扣	15. COM3 (RS-485) 通讯端口 (仅 DVP12SA2 支持)
8. COM2 (RS-485) 通讯端口	

■ 电气规格

项目 \ 机种 DVP	12SA211R	12SA211T	28SA211R	28SA211T	28SA211S
电源电压	24VDC (-15 ~ 20%) (具直流输入电源极性反接保护) DVPPS01/PS02: 输入 100 ~ 240 VAC, 输出 24 VDC/1 A (PS02: 2 A)				
连接方式	脱落式欧式端子座 (端点距离: 3.5 mm)				
动作规格	最大电源断电时间 ≤ 10ms				
突入电流	Max. 7.5 A@24 VDC, I ² t = 0.25A ² S				
电源保险丝容量	2.5A /30 VDC, 可恢复式(Polyswitch)				
消耗功率	1.8 W	1.5 W	2.9W	1.7W	1.7W
电源保护	具直流输入电源极性反接保护				
绝缘阻抗	> 5MΩ (所有输出 / 入点对地之间 500 VDC)				
干扰免疫力	ESD (IEC 61131-2, IEC 61000-4-2): 8kV Air Discharge EFT (IEC 61131-2, IEC 61000-4-4): Power Line: 2kV, Digital I/O: 1kV, Analog & Communication I/O: 1kV RS (IEC 61131-2, IEC 61000-4-3): 26MHz ~ 1GHz, 10V/m				

机种 DVP 项目	12SA211R	12SA211T	28SA211R	28SA211T	28SA211S
接地	接地配线的线径不得小于电源端配线线径（多台 PLC 同时使用时，请务必单点接地）				
操作 / 储存环境	操作：0 ~ 55°C（温度），5 ~ 95%（湿度），污染等级 2 储存：-25 ~ 70°C（温度），5 ~ 95%（湿度） 不可凝结				
耐振动 / 冲击	国际标准规范 IEC61131-2, IEC 68-2-6 (TEST Fc)/IEC61131-2 & IEC 68-2-27 (TEST Ea)				
重量 (g)	140g	131g	171g	134g	135g

机种 项目	输入点电气规格(单端共点输入)		
	12SA2 / 28SA2		28SA2
输入点 No.	X0 ~ X2 (12SA2) X0 ~ X3 (28SA2)	X3 ~ X7 (12SA2) X4 ~ X7 (28SA2)	X10~X17
输入接线型式	由端子 S/S 变换接线为漏型或源型		
输入信号电压 (±10%)	24 VDC, 5 mA		
输入阻抗	4.7 kΩ		
最大输入频率	100 kHz	10 kHz	50Hz
动作临界点	Off → On	> 15 VDC	
	On → Off	< 5 VDC	
反应时间	Off → On	< 2.5 μs	< 20 μs
干扰抑制	On → Off	< 5 μs	< 50 μs
滤波时间	由 D1020 可作 0 ~ 20 ms 的调整（默认：10 ms）		

机种 项目	输出点电气规格			
	继电器	晶体管(NPN & PNP)		
输出点 No.	Y0 ~ Y3	Y0, Y2	Y1, Y3	Y10~Y13
最高交换频率	1 Hz	100 kHz	10 kHz	1kHz ^{#5}
输出动作指示	LED 显示；灯亮表示为 ON，不亮表示为 OFF			
电压规格	100~250 VAC, 5~30 VDC ^{#4}	5 ~ 30 VDC ^{#1}		
漏电流	-	<100uA		
最大负载	电阻性	1.5 A / 1 点 (5 A/COM)	0.5 A / 1 点 (4 A/COM)	
	电感性	#2	15 W (30 VDC)	
	灯泡	20WDC/100WAC	2.5 W (30 VDC)	
最小负载	1mA / 5V		1mA/5V	
反应时间	Off → On	约 10 ms	2 μs ^{#3}	20 μs ^{#3}
	On → Off		3 μs ^{#3}	30 μs ^{#3}

#1：UP, ZP 必须外加辅助电源 24 VDC (-15 ~ +20%) 额定消耗约 1 mA / 点。

#2：继电器接点寿命随着工作电压、负载种类(功率因素 $\cos\phi$ 、时间常数 t)、及接点电流大小而有所不同，参考生命周期曲线图预估可操作次数。生命周期曲线图请参阅英文版 [Figure 2]。

#3：负载条件为 0.5A。

#4：此处最高输出速度会受实际 PLC 扫描时间影响。

■ 输入/输出配置

12SA211R	12SA211T	28SA211R	28SA211T	28SA211S																																																																																																													
继电器 8IN/4OUT	晶体管(NPN) 8IN/4OUT	继电器 16IN/12OUT	晶体管(NPN) 16IN/12OUT	晶体管(PNP) 16IN/12OUT																																																																																																													
直流 (Sink or Source)																																																																																																																	
<table border="1"> <tr><td>S/S</td></tr><tr><td>X0</td></tr><tr><td>X1</td></tr><tr><td>X2</td></tr><tr><td>X3</td></tr><tr><td>X4</td></tr><tr><td>X5</td></tr><tr><td>X6</td></tr><tr><td>X7</td></tr><tr><td>C0</td></tr><tr><td>Y0</td></tr><tr><td>Y1</td></tr><tr><td>Y2</td></tr><tr><td>Y3</td></tr><tr><td>●</td></tr><tr><td>S/G</td></tr><tr><td>COM3⁺</td></tr><tr><td>COM3-</td></tr></table>	S/S	X0	X1	X2	X3	X4	X5	X6	X7	C0	Y0	Y1	Y2	Y3	●	S/G	COM3 ⁺	COM3-	<table border="1"> <tr><td>S/S</td></tr><tr><td>X0</td></tr><tr><td>X1</td></tr><tr><td>X2</td></tr><tr><td>X3</td></tr><tr><td>X4</td></tr><tr><td>X5</td></tr><tr><td>X6</td></tr><tr><td>X7</td></tr><tr><td>Y0</td></tr><tr><td>Y1</td></tr><tr><td>Y2</td></tr><tr><td>Y3</td></tr><tr><td>UP</td></tr><tr><td>ZP</td></tr><tr><td>S/G</td></tr><tr><td>COM3⁺</td></tr><tr><td>COM3-</td></tr></table>	S/S	X0	X1	X2	X3	X4	X5	X6	X7	Y0	Y1	Y2	Y3	UP	ZP	S/G	COM3 ⁺	COM3-	<table border="1"> <tr><td>S/S</td></tr><tr><td>X0</td></tr><tr><td>X1</td></tr><tr><td>X2</td></tr><tr><td>X3</td></tr><tr><td>X4</td></tr><tr><td>X5</td></tr><tr><td>X6</td></tr><tr><td>X7</td></tr><tr><td>S/S</td></tr><tr><td>X10</td></tr><tr><td>X11</td></tr><tr><td>X12</td></tr><tr><td>X13</td></tr><tr><td>X14</td></tr><tr><td>X15</td></tr><tr><td>X16</td></tr><tr><td>X17</td></tr></table>	S/S	X0	X1	X2	X3	X4	X5	X6	X7	S/S	X10	X11	X12	X13	X14	X15	X16	X17	<table border="1"> <tr><td>C0</td></tr><tr><td>Y0</td></tr><tr><td>Y1</td></tr><tr><td>Y2</td></tr><tr><td>●</td></tr><tr><td>C1</td></tr><tr><td>Y3</td></tr><tr><td>Y4</td></tr><tr><td>Y5</td></tr><tr><td>C2</td></tr><tr><td>Y6</td></tr><tr><td>Y7</td></tr><tr><td>Y10</td></tr><tr><td>●</td></tr><tr><td>C3</td></tr><tr><td>Y11</td></tr><tr><td>Y12</td></tr><tr><td>Y13</td></tr></table>	C0	Y0	Y1	Y2	●	C1	Y3	Y4	Y5	C2	Y6	Y7	Y10	●	C3	Y11	Y12	Y13	<table border="1"> <tr><td>S/S</td></tr><tr><td>X0</td></tr><tr><td>X1</td></tr><tr><td>X2</td></tr><tr><td>X3</td></tr><tr><td>X4</td></tr><tr><td>X5</td></tr><tr><td>X6</td></tr><tr><td>X7</td></tr><tr><td>S/S</td></tr><tr><td>X10</td></tr><tr><td>X11</td></tr><tr><td>X12</td></tr><tr><td>X13</td></tr><tr><td>X14</td></tr><tr><td>X15</td></tr><tr><td>X16</td></tr><tr><td>X17</td></tr></table>	S/S	X0	X1	X2	X3	X4	X5	X6	X7	S/S	X10	X11	X12	X13	X14	X15	X16	X17	<table border="1"> <tr><td>UP0</td></tr><tr><td>ZP0</td></tr><tr><td>Y0</td></tr><tr><td>Y1</td></tr><tr><td>Y2</td></tr><tr><td>Y3</td></tr><tr><td>Y4</td></tr><tr><td>Y5</td></tr><tr><td>Y6</td></tr><tr><td>Y7</td></tr><tr><td>●</td></tr><tr><td>UP1</td></tr><tr><td>ZP1</td></tr><tr><td>Y10</td></tr><tr><td>Y11</td></tr><tr><td>Y12</td></tr><tr><td>Y13</td></tr><tr><td>●</td></tr></table>	UP0	ZP0	Y0	Y1	Y2	Y3	Y4	Y5	Y6	Y7	●	UP1	ZP1	Y10	Y11	Y12	Y13	●
S/S																																																																																																																	
X0																																																																																																																	
X1																																																																																																																	
X2																																																																																																																	
X3																																																																																																																	
X4																																																																																																																	
X5																																																																																																																	
X6																																																																																																																	
X7																																																																																																																	
C0																																																																																																																	
Y0																																																																																																																	
Y1																																																																																																																	
Y2																																																																																																																	
Y3																																																																																																																	
●																																																																																																																	
S/G																																																																																																																	
COM3 ⁺																																																																																																																	
COM3-																																																																																																																	
S/S																																																																																																																	
X0																																																																																																																	
X1																																																																																																																	
X2																																																																																																																	
X3																																																																																																																	
X4																																																																																																																	
X5																																																																																																																	
X6																																																																																																																	
X7																																																																																																																	
Y0																																																																																																																	
Y1																																																																																																																	
Y2																																																																																																																	
Y3																																																																																																																	
UP																																																																																																																	
ZP																																																																																																																	
S/G																																																																																																																	
COM3 ⁺																																																																																																																	
COM3-																																																																																																																	
S/S																																																																																																																	
X0																																																																																																																	
X1																																																																																																																	
X2																																																																																																																	
X3																																																																																																																	
X4																																																																																																																	
X5																																																																																																																	
X6																																																																																																																	
X7																																																																																																																	
S/S																																																																																																																	
X10																																																																																																																	
X11																																																																																																																	
X12																																																																																																																	
X13																																																																																																																	
X14																																																																																																																	
X15																																																																																																																	
X16																																																																																																																	
X17																																																																																																																	
C0																																																																																																																	
Y0																																																																																																																	
Y1																																																																																																																	
Y2																																																																																																																	
●																																																																																																																	
C1																																																																																																																	
Y3																																																																																																																	
Y4																																																																																																																	
Y5																																																																																																																	
C2																																																																																																																	
Y6																																																																																																																	
Y7																																																																																																																	
Y10																																																																																																																	
●																																																																																																																	
C3																																																																																																																	
Y11																																																																																																																	
Y12																																																																																																																	
Y13																																																																																																																	
S/S																																																																																																																	
X0																																																																																																																	
X1																																																																																																																	
X2																																																																																																																	
X3																																																																																																																	
X4																																																																																																																	
X5																																																																																																																	
X6																																																																																																																	
X7																																																																																																																	
S/S																																																																																																																	
X10																																																																																																																	
X11																																																																																																																	
X12																																																																																																																	
X13																																																																																																																	
X14																																																																																																																	
X15																																																																																																																	
X16																																																																																																																	
X17																																																																																																																	
UP0																																																																																																																	
ZP0																																																																																																																	
Y0																																																																																																																	
Y1																																																																																																																	
Y2																																																																																																																	
Y3																																																																																																																	
Y4																																																																																																																	
Y5																																																																																																																	
Y6																																																																																																																	
Y7																																																																																																																	
●																																																																																																																	
UP1																																																																																																																	
ZP1																																																																																																																	
Y10																																																																																																																	
Y11																																																																																																																	
Y12																																																																																																																	
Y13																																																																																																																	
●																																																																																																																	

注：本机种输出端子配置与 DVP-SA 系列不同，使用时请注意配线之变更。

■ 安装方式

PLC 在安装时，请装配于封闭式的控制箱内，其周围应保持一定的空间，以确保 PLC 散热功能正常，请参阅英文版[Figure 3]。

- 直接锁螺丝方式：请依产品外型尺寸并使用 M4 螺丝。
- DIN 铝轨的安装方法：适用于 35mm 的 DIN 铝轨。在将主机挂上铝轨时，请先将主机（或 I/O 模块）下方的固定塑料片，以一字形起子插入凹槽并向外撑开拉出，再将主机（或 I/O 模块）挂上铝轨，之后将固定塑料片压扣回去即可。欲取下主机时，同样以一字形起子先将固定塑料片撑开，再将主机以往外向上的方式取出即可。该固定机构塑料片为保持型，因此撑开后便不会弹回去。

■ 配线端子

1. 输出 / 入配线端请使用 22 ~ 16AWG (1.5mm) 单蕊裸线或多蕊线，端子规格如英文版配线端子之图示。PLC 端子螺丝扭力为 1.90 kg-cm (1.65 in-lbs)。只能使用 60/75°C 的铜导线。
2. 空端子请勿配线。输入点信号线与输出点等动力线请勿置于同一线槽内。
3. 锁螺丝及配线时请避免微小的金属导体掉入 PLC 内部，并在配线完成后保持散热空间。

◆ 电源端

DVP-SA2 机种为直流电源输入，在使用上应注意下列事项：

1. 电源请接于 24 VDC 及 0 V 两端，电源范围为 20.4 ~ 28.8 VDC，当电源电压低于 17.5 VDC 时，PLC 会停止运行，输出全部 Off，ERROR LED 快速闪烁。
2. 当停电时间低于 10 ms 时，PLC 不受影响继续运转，当停电时间过长或电源电压下降将使 PLC 停止运转，输出全部 Off，当电源恢复正常时，PLC 亦自动回复运转。(PLC 内部具停电保持的辅助继电器及寄存器，使用者在规划程序设计时应特别注意使用。)

◆ 安全配线回路

由于 DVP-SA2 的电源为 DC Only 的机种，因此可搭配台达的电源供应模块 (DVPPS01/DVPPS02) 提供电源给 DVP-SA2。为保护 DVPPS01/DVPPS02，建议可在电源的输入回路端配置如下的保护回路，配置图请参阅英文版 [Figure 4] 所示：

① 交流供应电源：100 ~ 240 VAC, 50/60 Hz	② 断路器
③ 紧急停止：为预防突发状况发生，设置紧急停止按钮，可在状况发生时，切断系统电源。	
④ 电源指示灯	⑤ 交流电源负载
⑥ 电源回路保护用保险丝（2A）	⑦ DVPPS01/DVPPS02 本体
⑧ 直流供应电源输出：24 VDC，500 mA	⑨ DVP PLC 本体
⑩ 数字量输入 / 输出模块	

◆ 输入点的配线

输入点的接入信号为直流电源 DC 输入，DC 型式共有两种接法：漏型及源型，其定义与输入点回路等效电路配线图，请参阅英文版 [Figure 5] 及 [Figure 6]。

◆ 输出点的配线

1. DVP-SA2 系列 PLC 输出模块共有三种：继电器、晶体管-NPN 与晶体管-PNP。输出端在实际配线时，应特别注意共享端的连接。
2. 继电器机种 12SA2 输出端 Y0 ~ Y3 采用 C0 共点，请参阅英文版 [Figure 7] 28SA211R 输出端配置之共点配置，请参阅英文版 [Figure 8]。动作指示：当输出点动作时，正面的该点指示灯亮。
3. 晶体管机种输出端采用 UP、ZP 共点设计，12SA2-T、28SA2-T 与 28SA2-S 之配置，请分别参阅英文版 [Figure 9]、[Figure 10] 与 [Figure 11]。
4. 隔离回路：PLC 内部回路 with 输出点之间使用光耦合器作信号隔离。

● 继电器输出回路配线

详细配线图请参阅英文版 [Figure 12] ~ [Figure 14]。

① 直流电源供给	② 紧急停止：使用外部开关
③ 保险丝：于输出接点的公共端使用容量 5 ~ 10A 的保险丝，保护输出点回路	
④ 突波吸收二极管：可增加接点寿命。 <ol style="list-style-type: none">1. DC 负载电源的二极管抑制：功率较小时使用（请参阅英文版 [Figure 13a]）2. DC 负载电源的二极管 + Zener 抑制：大功率及 On/Off 频繁时使用（请参阅英文版 [Figure 13b]）。	
⑤ 白炽灯（电阻性负载）	
⑥ 突波吸收器：可减少交流负载上的干扰（请参阅英文版 [Figure 14]）	

● 晶体管输出回路配线

详细配线图请参阅英文版 [Figure 15] ~ [Figure 18b]。

① 直流供应电源	② 紧急停止	③ 电路回路保护用保险丝
④ 突波吸收二极管：可增加接点寿命。 <ol style="list-style-type: none">1. DC 负载电源之二极管抑制：功率较小时使用（请参阅英文版 [Figure 17a] [Figure 18a]）2. DC 负载电源之二极管 + Zener 抑制：大功率且 On/Off 频繁时使用（请参阅英文版 [Figure 17b] [Figure 18b]）		
⑤ 互斥输出：例如，将 Y2 与 Y3 用以控制对应马达的正转及反转，使外部电路形成互锁，配合 PLC 内部程序，确保任何异常突发状况发生时，均有安全的保护措施。		

◆ RS-485 建议接线

详细接线图请参阅英文版 [Figure 19]。DVP12SA2 提供 COM2, COM3 两组; DVP28SA2 仅提供 COM2 一组。

① 主站

② 从站

③ 终端电阻

④ 屏蔽线

注：1. 终端电阻建议连接于主站及最后一台从站上，且其阻值建议为 120Ω。

2. 为确保联机质量，线材建议使用具有双层屏蔽线的通讯双绞线（20AWG）。

■ 万年历的精度（秒 / 月）

温度 (°C/°F)	0/32	25/77	55/131
最大误差 (秒)	-117	52	-132

万年历停电保持时间：一周